

PARERE

A network for discussing the regulatory need and relevance of new testing methods and approaches

Dr. B. Mertens

FAGG/FAMHP Conference Conference 'Advancing the 3Rs for regulatory testing of Medicines'
31st of January, Antwerp, Belgium

European legislation

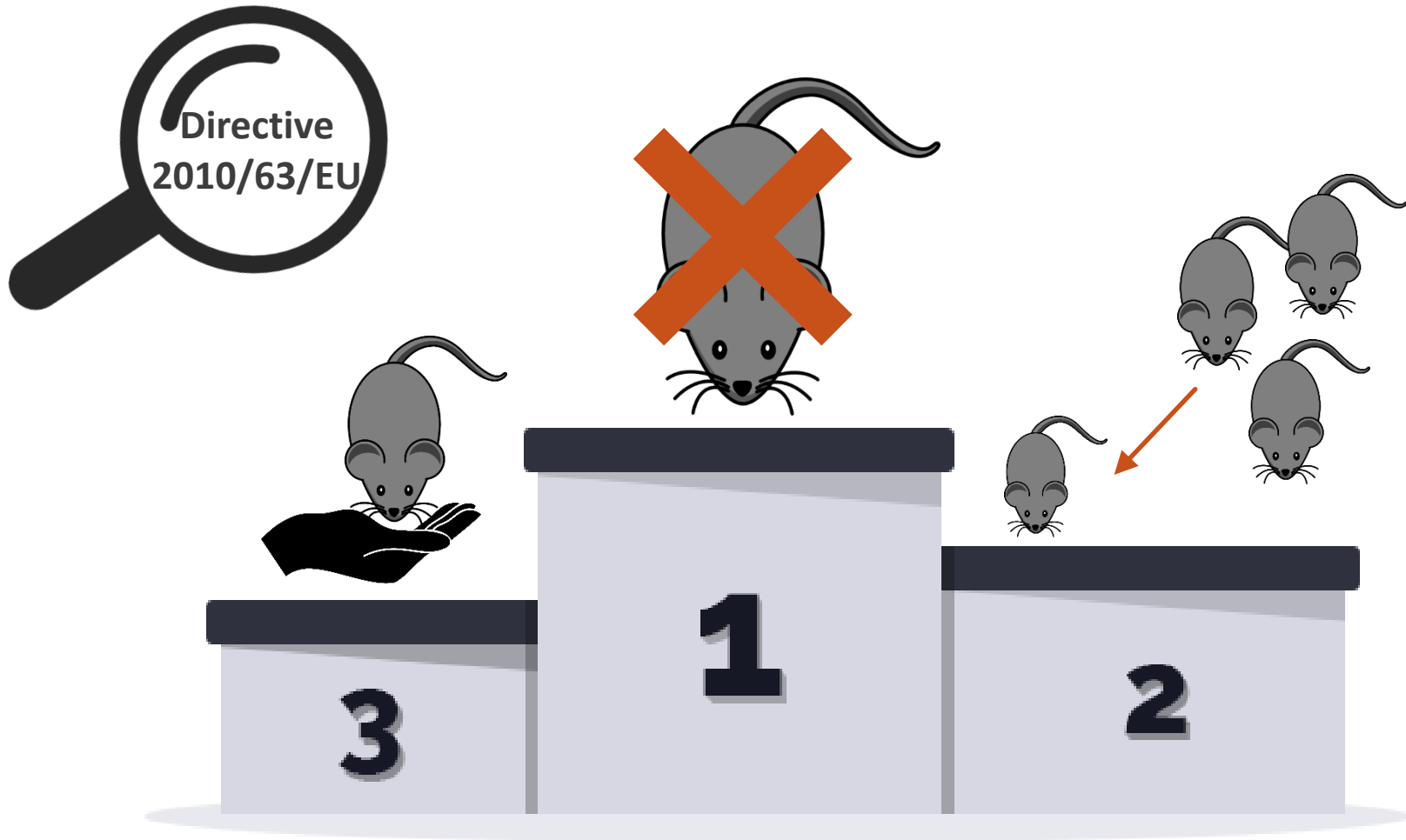

➔ Creation of EURL ECVAM and different European networks

EURL ECVAM



'European Union Reference Laboratory for Alternatives to Animal Testing'



VALIDATION

Reliability - Relevance - Aim



COMMUNICATION

Between different stakeholders



DISSEMINATION

Active distribution of information

ICATM cooperation

Stakeholder dialogue

ECVAM Validation Process

Key documents

ICATM: Exchange Information on promising submissions. Select mode of collaborative activity.

Relevance assessment:

- PARERE: regulatory relevance
- ESTAF: user relevance

1. Assessment of submitted test method
Scientific aspects. Stakeholder relevance (priority setting). Optimisation (if necessary).

Test Submission

PARERE report | ESTAF View

ICATM: Technical aspects of VS. Propose VMG members. Second liaison members (=observers).

Public input on planned Validation Study. Submission of existing information.

2. Planning & conduct of (Pre-)Validation Study (VS). → Test method evaluation.

Validation Project Plan (VPP)

Validation Study Report (VSR)

ICATM: Proposal of experts for the ESAC WG supporting the ESAC peer review.

3. ESAC review of (1) VS conduct (2) VS conclusions → (3) **ESAC opinion on test method's validity for purpose.**

ESAC Request

ESAC Reports & Opinion

ICATM: Harmonised recommendations of validated test methods (if feasible).

Comments on draft recommendation:

- PARERE
- ESTAF

4. Draft ECVAM Recommendations on validated test method.

5. 'Right to be heard' process.

Draft ECVAM Recommendation

PARERE report | ESTAF View

Public input on draft ECVAM recommendations

6. Public Commenting

Public Commenting Report

7. Finalisation of ECVAM recommendations (ER). Publication of ER + ESAC opinion + VSR.

ECVAM Recommendation

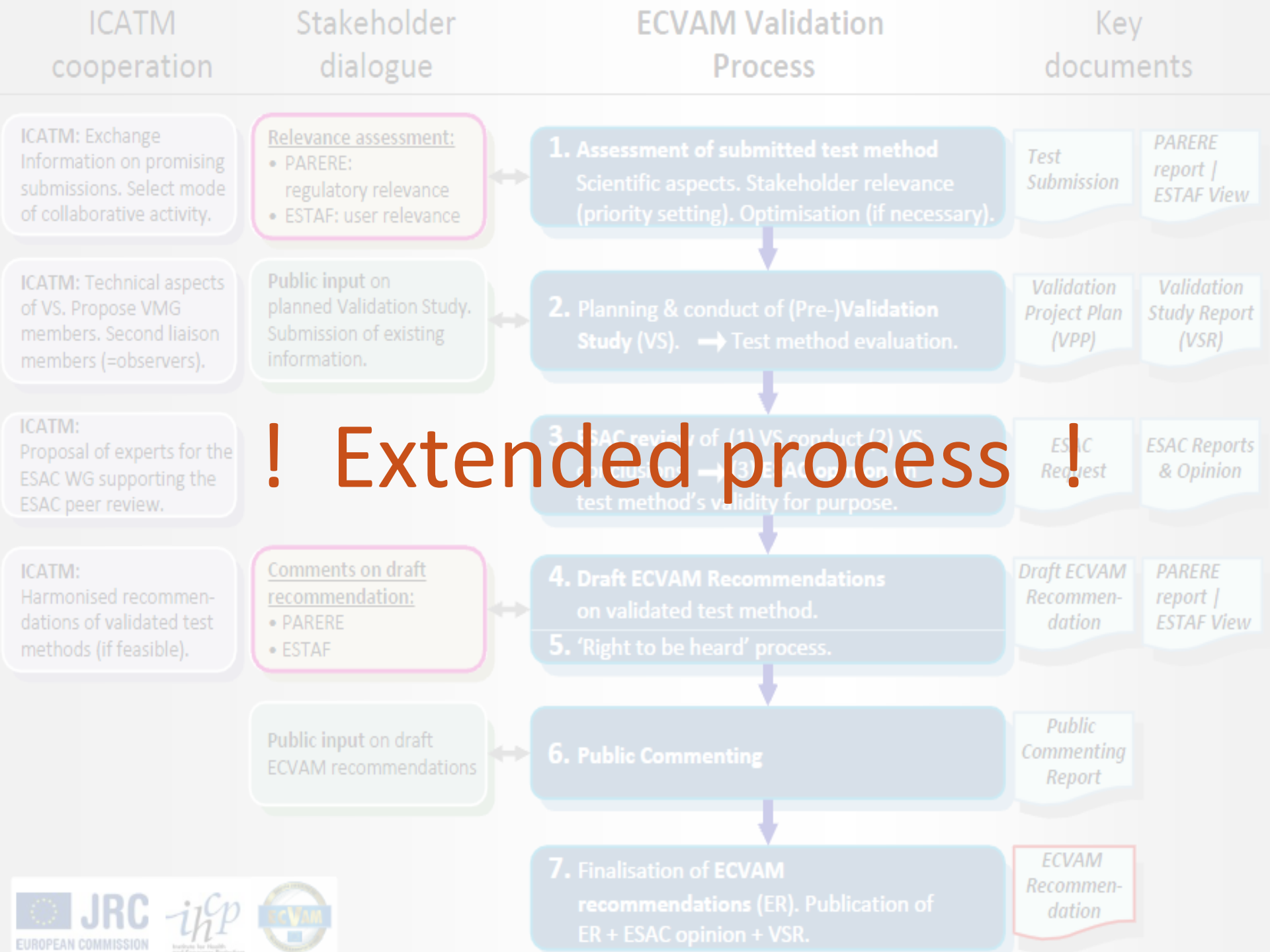

! Extended process !

EURL ECVAM: validation



2014



2008



EURL ECVAM: validation



Increased need for laboratory capacity



SIXTH FRAMEWORK
PROGRAMME



SEVENTH FRAMEWORK
PROGRAMME

2014



Regulatory relevance of submitted methods often unclear



2008



EU-NETVAL



'EU Network of Laboratories for the Validation of Alternative Methods'

AIM: Support validation studies of EURL ECVAM

COORDINATION: EURL ECVAM with DG Environment and the NCPs

MEMBERS: 35 (last call 09/2015)

1. Sciensano – Quality of Vaccines and Blood Products
2. VITO-ABS – Research team Applied Bio & molecular Systems

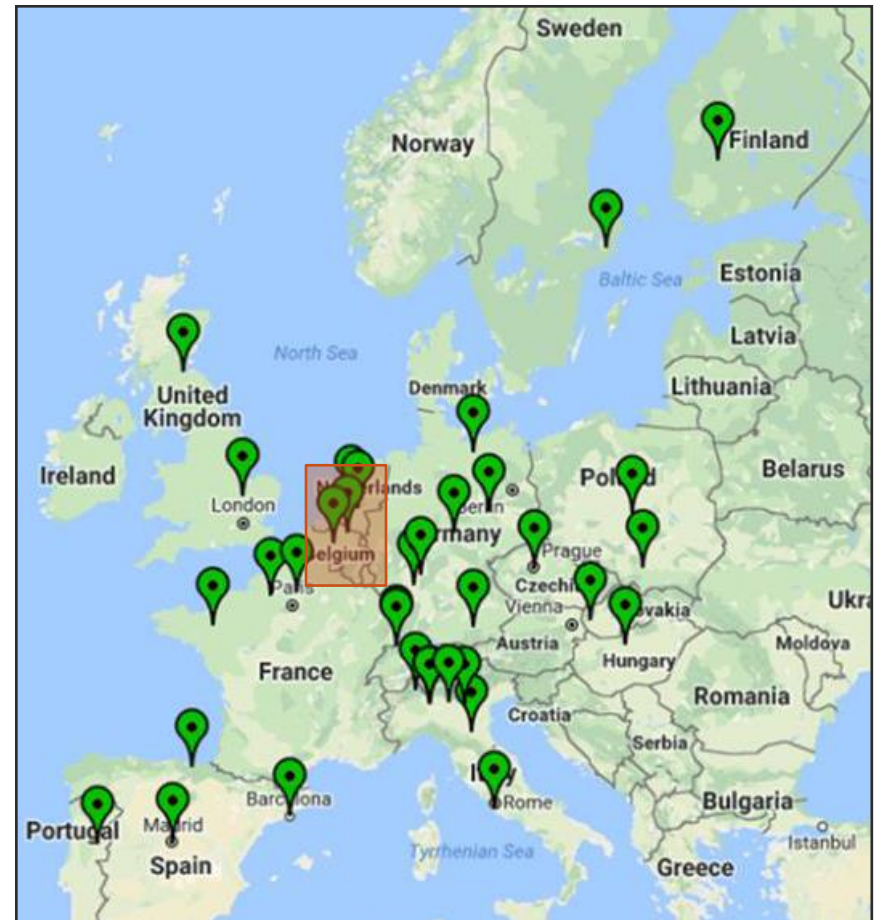

EU-NETVAL



- 15 EU-NETVAL facilities have been assigned to work on 18 in vitro methods – results of the validation study are being evaluated at OECD by a panel of experts

TSAR

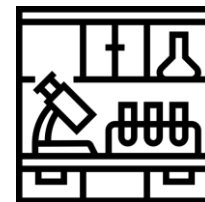

TSAR - Tracking System for Alternative methods towards Regulatory acceptance

European Commission > EU Science Hub > EURL ECVAM > TSAR



TRACKING SYSTEM FOR ALTERNATIVE METHODS TOWARDS REGULATORY ACCEPTANCE

TSAR tracks the progress of alternative, non-animal methods, for testing chemicals or biological agents such as vaccines towards acceptance as a recognised test method for use in various sectors



TSAR indicates the stages methods have reached in terms of acceptance as a recognised test method for use in various sectors together with a summary description. Where available, TSAR also includes relevant records and documents associated with a method linked to the different steps of the entire process: [submission](#), [validation](#), [peer-review](#), recommendations and regulatory acceptance including international standards represented in the tracking system.

Thyroid method 4a: Deiodinase 1 activity based on Sandell-Kolthoff reaction

TM Status:



Open

Topic(s):

Endocrine disruption

Test Method Number:

TM2019-10 (EU)

Short Name of TM:

DIO1-SKR

Responsible Organisation:

[EURL ECVAM - European Union](#)

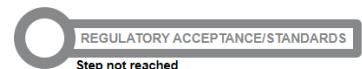
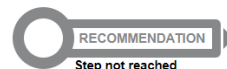

<https://tsar.jrc.ec.europa.eu/>

PARERE network



'Network for Preliminary Assessment of Regulatory Relevance of alternative methods and approaches'



PARERE representative in
30 EU member states
(BE: *Sciensano*)



Exchange of knowledge on NAMs with regulators

BE PARERE network

Link between the PARERE contact point, the **National Coordinator of the OECD Test Guidelines Programme (NC)** and the National Contact Point for implementation of Directive 2010/63

Convention entre l'Institut Scientifique de Santé Publique (ISP), la Région flamande, la Région wallonne et la Région de Bruxelles-Capitale concernant la désignation d'un point de contact unique chargé de fournir des conseils sur la pertinence réglementaire et l'opportunité des approches alternatives proposées pour validation (le point de contact PARERE).

Overeenkomst tussen het Wetenschappelijk Instituut Volksgezondheid (WIV), het Vlaamse Gewest, het Waalse Gewest en het Brussels Hoofdstedelijk Gewest betreffende de aanduiding van een contactpunt dat advies uitbrengt over de relevantie van regelgeving en de geschiktheid van alternatieve benaderingen die ter validering worden voorgesteld (het PARERE contactpunt).

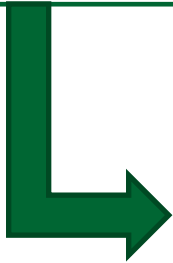

BE PARERE network

BE experts from different regulatory domains

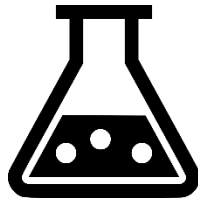

Role of PARERE has evolved – type of experts needed has changed

In practice

1 Coordination of advice from Belgian experts and the Belgian participation in EU-NETVAL



2 Organisation of 2 meetings of the BE PARERE network and 1 with the NCPs



3 Preparation and participation to the yearly PARERE/ESTAF meeting



Coordination of advice

Requests from EURL ECVAM/JRC

Individual methods



Strategies

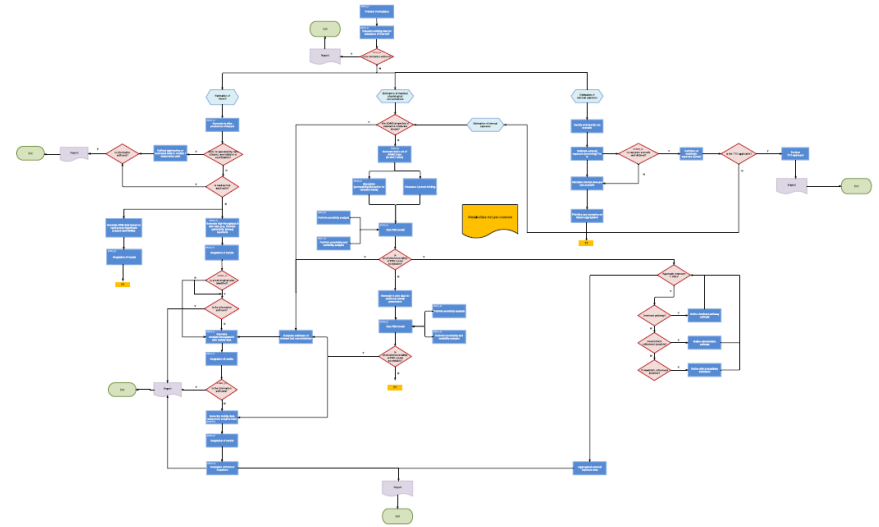

EUROPEAN COMMISSION
DIRECTORATE-GENERAL JOINT RESEARCH CENTRE
Directorate F - Health, Consumers and Reference Materials
European Union Reference Laboratory for Alternatives to Animal Testing (EURL ECVAM)

**EURL ECVAM
TEST PRESUBMISSION FORM (TPF)**
To Allow for a Preliminary Assessment of the
Development/Validation Status of a Test Method



Coordination of advice

Requests from other organisations

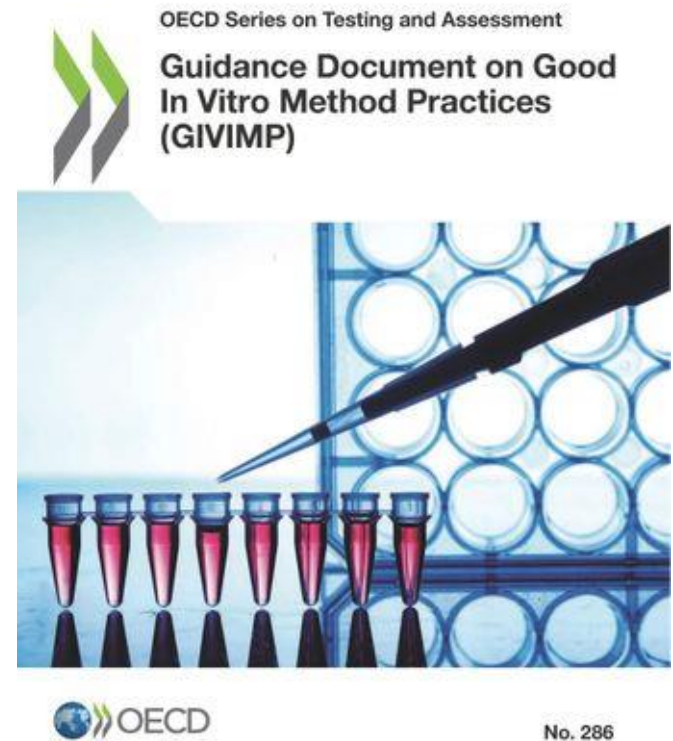

EU PARERE/ESTAF Meeting



European
Commission

Draft Agenda

**12th meeting of the
Preliminary Assessment of
Regulatory Relevance
(PARERE) network**

Joint Research Centre, Ispra, Italy

30 March 2023

Joint
Research
Centre



European
Commission

Draft Agenda

**PARERE-ASPIS Workshop
on how to best achieve
Regulatory Relevant
Research**

Joint Research Centre, Ispra, Italy

30-31 March 2023

Joint
Research
Centre

Meetings of BE PARERE network



healthy all life long

BE PARERE NETWORK MEETING

Post EU PARERE Meeting

19th of July 2023, Virtual meeting via WebEx

.be

Diverse regulatory relevant topics

- EU H2020 research projects including ONTOX, ALTERNATIVE,...
- Updates of EURL ECVAM
- Progress on the regulatory uptake of NAMs
- EMA 3R Working Group
- Endocrine Disruption
- OMCL activities
- ..

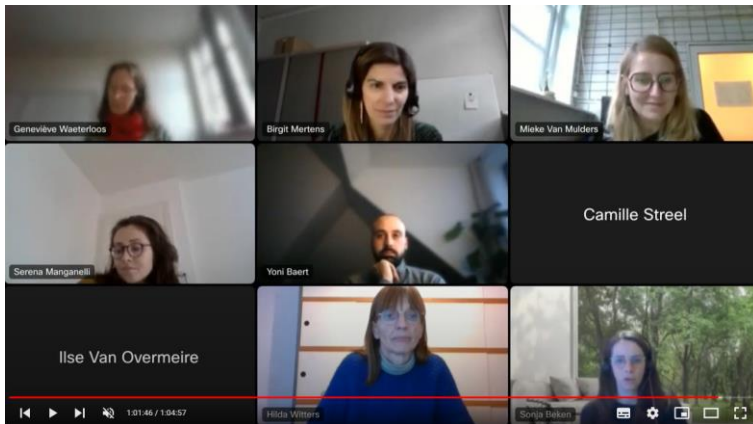

Overall goal

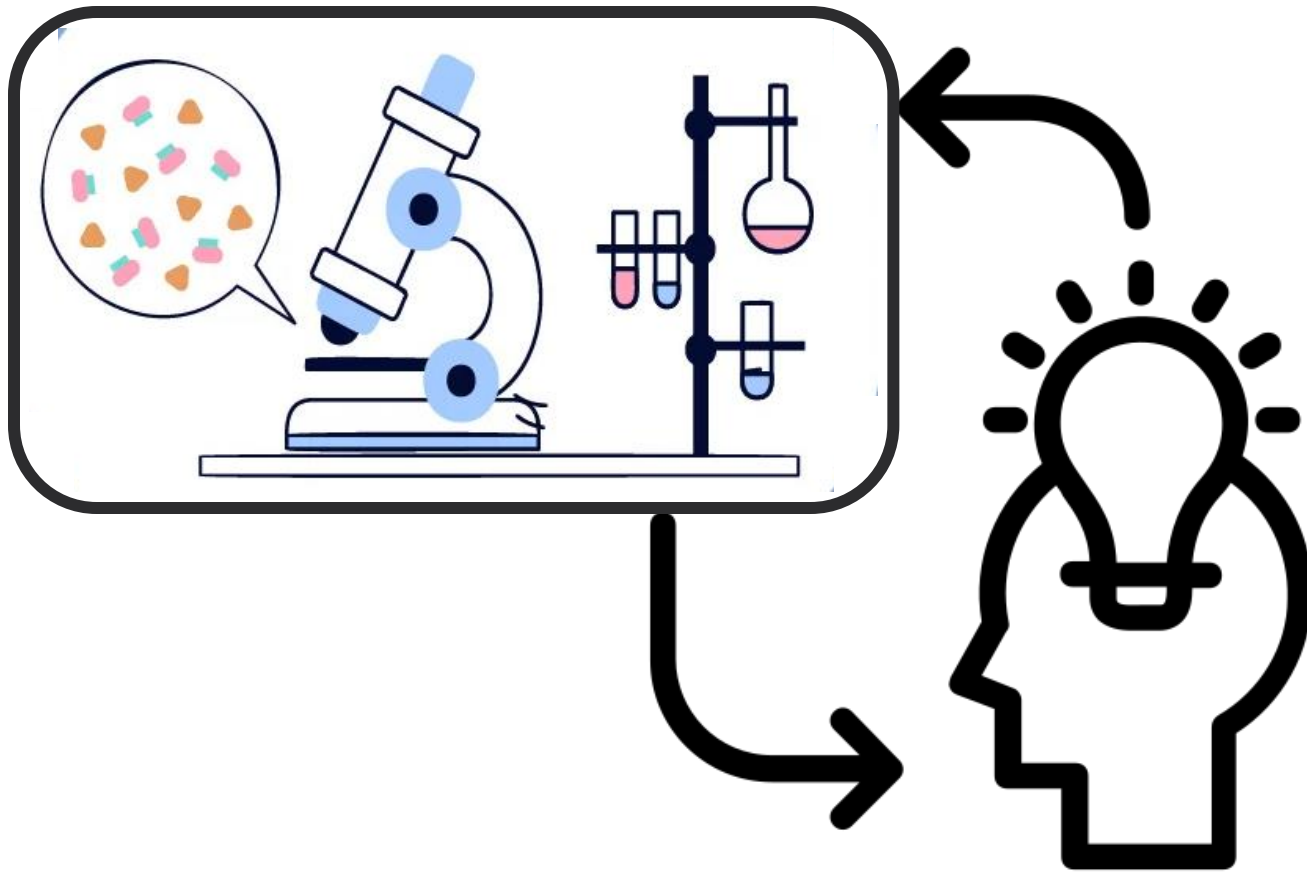

Contact

Birgit Mertens • birgit.mertens@sciensano.be • +32 2 642 54 40

Mieke Van Mulders • mieke.vanmulders@sciensano.be • +32 2 642 52 52